



# Fixed Gas & Flame Detection

International Product Range Overview



Over 100 years of experience and capability in comprehensive safety solutions have made MSA Safety a modern and forward-looking company for the protection of people, facilities, and the environment. MSA Safety is one of the few suppliers of fixed gas and flame detection (FGFD) measurement technology that develops and manufactures a comprehensive range of products and integrates them into safety solutions.

Our expertise in gas and flame detection demonstrates that the correct mix of durable products and innovative technology increases safety, while driving operational efficiency.

We have a wide range of sensing technologies for gas and flame detection. We create solutions that not only help to increase worker safety and protect facilities, but also decrease overall cost of ownership.

SAFEGUARDING  
**PEOPLE, PLACES & THE PLANET**

## Selection Guide: The Right Gas Detector

	Product Type										
	UL147M® K0000	General Purpose® S0000	General Purpose® UL147M-DE	PriMark® 1	PriMark® P	PriMark® 1B	PriMark® 1B+	Solar-40K	Smart ELD®	General Purpose® IP5000	General Purpose® Observer® 1
<b>Detection Principle</b>											
Catalytic combustion sensor	■	■			■			■			
Electrochemical sensor	■	■	■	■	■						
Semiconductor sensor		■									
Infrared Point detection	■	■				■					
Open Path detection								■		■	
Ultrasonic											■
<b>Units of Measure</b>											
0-100 % LEL	■	■			■	■		■			
% Volume		■	■								
0-5 LEL/m									■	■	
ppm	■	■	■	■	■						
ppm/m									■	■	
40-120 dB (α)											■
<b>Detectable Gases</b>											
Ammonia (NH <sub>3</sub> )	■	■	■	■	■				■		■
Carbon Monoxide (CO)	■	■	■	■	■						
Carbon Dioxide (CO <sub>2</sub> )	■								■		■
Chlorine (Cl <sub>2</sub> )	■	■	■	■	■						
Chlorine Dioxide (ClO <sub>2</sub> )	■	■	■								
Ethylene (C <sub>2</sub> H <sub>4</sub> )	■	■			■	■	■	■		■	■
Ethylene Oxide (EO)	■	■	■								
Hydrocarbon Combustible Gases	■	■			■	■	■			■	■
Hydrogen (H <sub>2</sub> )	■	■	■	■	■		■				■
Hydrogen Cyanide (HCN)	■	■	■	■	■						
Hydrogen Sulphide (H <sub>2</sub> S)	■	■	■	■	■				■		
Hydrogen Chloride (HCl)	■	■	■	■	■				■		
Hydrogen Fluoride (HF)	■	■	■								
Methane (CH <sub>4</sub> )	■	■			■	■	■	■		■	■
Nitrogen Oxide (NO)	■	■	■	■	■						
Nitrogen Dioxide (NO <sub>2</sub> )	■	■	■	■	■						
Oxygen (O <sub>2</sub> )	■	■	■	■	■						
Propane (C <sub>3</sub> H <sub>8</sub> )	■	■			■	■	■			■	■
Sulphur Dioxide (SO <sub>2</sub> )	■	■	■	■	■						

Please visit [www.MSA.com](http://www.MSA.com) for more information on our products and services.

## Explosion-Proof Detectors

### ULTIMA<sup>®</sup> X5000 Gas Monitor

The ULTIMA X5000 Gas Monitor offers advanced technologies detecting oxygen, toxic, and combustible gases.

*Key features:*

- TruCal<sup>®</sup> simulated calibration technology extends manual calibration intervals up to 24 months for XCell<sup>™</sup> H<sub>2</sub>S and CO sensors
- High visibility and intuitive display with full-word text available in 9 languages
- Tool-free operation with touch-enabled display
- Dual sensing and universal board design lowers project installation costs
- Bluetooth<sup>®</sup> application provides easy configuration for faster start-ups
- Remote sensor calibration from a safe location with CalGuard RCA



### General Monitors<sup>®</sup> S5000 Gas Monitor

The S5000 Gas Monitor is the ultimate gas detector for extreme environments requiring detection of oxygen, toxic, and combustible gases.

*Key features:*

- Performs over a wide temperature range (-67°F / -55°C) to (+167°F / +75°C)
- TruCal simulated calibration technology extends manual calibration intervals up to 24 months for XCell H<sub>2</sub>S and CO sensors
- Dual sensing lowers project installation costs
- Backwards compatible with selected S4000 TH and S4000CH sensors
- Bluetooth<sup>®</sup> application provides easy configuration for faster start-ups
- Remote sensor calibration from a safe location with CalGuard RCA

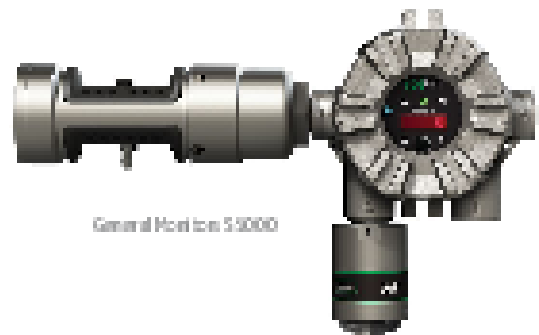

## Flame Detectors

### General Monitors<sup>®</sup> FL5000 MSIR Flame Detector

- Advanced multi-spectrum infrared optical flame detector for hydrocarbon fires
- Enhanced Artificial Neural Network (ANN) technology for reliable discrimination between actual flames and false alarm sources
- FM performance approved for 22 fuel sources
- Detection range up to 95 m (310 ft)
- HART and Modbus communication options
- Bluetooth for easy configuration and diagnostics via Flame Connect app

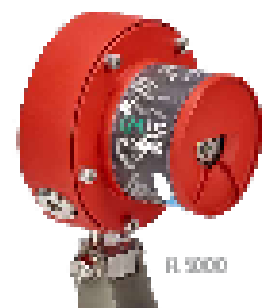

### General Monitors<sup>®</sup> FL500 UW/IR Flame Detector

- Ultraviolet/infrared flame detector detects hydrocarbon fires fast
- Six fuel sources FM performance approved
- Wide field of view for greater fire detection coverage
- HART and Modbus communication options
- Hydrogen-specific flame detector also available

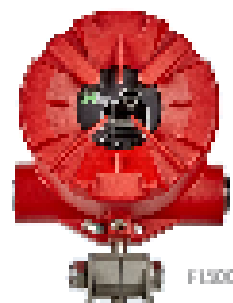

## Gas Detectors

### PrimaX® Series

The PrimaX transmitter range detects a wide range of toxic, oxygen and combustible gases.

#### PrimaX® I

- Electrochemical sensors for toxic gases and oxygen
- Robust, anti-static, reinforced nylon housing
- LCD display and optional HART



PrimaX I

PrimaX I P

#### PrimaX® P

- Detects combustible toxic gases or oxygen
- Flameproof coated aluminium enclosure
- LCD display, 3 LED status indicators and optional HART



PrimaX IR



PrimaX IR+

#### PrimaX® IR / PrimaX® IR+

- Hydrocarbon detection in LEL range
- Redundant infrared dual source technology
- Setup, calibration, and maintenance via HART
- Gas level and device status are available via the 4-20 mA output (PrimaX IR)
- Display with indicators for local status awareness and relay outputs (PrimaX IR+)

### Series 47K

Series 47K are cost effective passive catalytic sensors detecting potentially hazardous concentrations of flammable gas and vapour in air.

#### Key features:

- Available in poison resistant (PRP) or high temperature (HT) versions
- Large range of approved gases according to ATEX Directive 2014/54/EU
- Complete range of accessories and junction boxes
- 3, 4 or 5 wire connection



### ULTIMA® X

The ULTIMA XE 2-wire version provides continuous monitoring of toxic gases and oxygen deficiency using electrochemical sensor technology.

#### Key features:

- Operates with a wide range of toxic gases and oxygen
- Easy to read, large LCD display
- Sensor replacement under power
- Optional HART

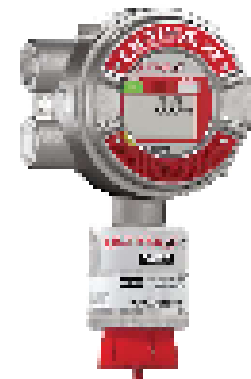

ULTIMA XE

## Open Path and Ultrasonic

### Sensient ELDS™ Open Path Gas Detector

A laser-based open path gas detector for the detection of toxic or flammable gases. Using a separate transmitter, receiver arrangement it is certified for use in hazardous areas. Available for open area detection (5-200 m gas dependent) and ventilation air intakes (0.5-5.0 m Methane only).

*Key features:*

- Target gas specific—no false alarms
- Gases detected: ammonia, carbon dioxide, hydrogen chloride, hydrogen sulphide, ethylene, methane, sour gas (H<sub>2</sub>S/Methane)
- Fast speed of response (<5 seconds)—fast initiation of safety actions
- SimuGas daily automatic self test—no routine manual testing
- Factory lifetime calibration—no routine recalibration required
- No consumable sensing elements—reduced operational cost



### General Monitors® IR5500 Open Path Infrared Gas Detector

The IR5500 Open Path Infrared Gas Detector provides continuous monitoring of flammable gases.

*Key features:*

- Sensitive to small (ppm/m) and large (LbL/m) gas leaks
- Ideal for harsh environments (-67°F / -55°C)
- Continuous self-check for fail-to-safe operation
- Multiple communication outputs (HART, Modbus, AMS support)



### General Monitors® Observer® i Ultrasonic Gas Leak Detector

The Observer i responds extremely fast to the airborne ultrasound generated from pressurized gas releases in open ventilated areas.

*Key features:*

- Artificial Neural Network (ANN) distinguishes real gas leak noise and suppresses false alarm sources
- Patented Sensonic® self-test ensures fail-safe operation
- Trouble-free maintenance and one-person check and calibration
- AISI 316L stainless steel housing end-closure
- Explosion proof design, Exd



## Controllers

### Importance of using a certified gas detection controller

The controller is a crucial part of any stationary gas detection system. It operates continuously to monitor work sites for the presence of combustible and toxic mixtures of gas and/or vapour with air and to monitor the ambient air for oxygen content. The control unit provides power for the connected detectors and transmitters, signal conditioning and displays measured gas concentrations. In addition, it monitors the limit values, actuates alarm devices and initiates risk reduction measures. According to the various international and national manufacturer and user regulations in explosion protection and health & safety at the workplace, the gas detection systems, including detectors and controllers, must be performance approved in order to minimize risk.

### SUPREMA Touch

SUPREMA Touch is a gas and fire warning system for large area measuring.

#### Key features:

- Processes up to 256 inputs and 512 outputs
- Multi-lingual touchscreen enabling intuitive operation
- New software enabling remote, one-man and group calibration
- SIL3 compatible due to the option of redundant input cards
- SUPREMA Manager software saves set-up time due to parametrization can be initiated offline
- Optional interfaces to external systems via Modbus RTU and TCP, Profibus and Profinet

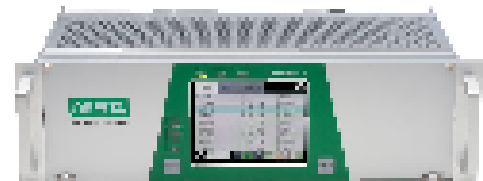

SUPREMA Touch

### SENTRY io<sup>®</sup>

The SENTRY io is an easily-configurable wall-mount multi-channel controller suitable for a variety of industrial applications.

#### Key features:

- Monitors up to 16 inputs and 56 outputs with an option for analog outputs
- Modern multi-lingual touchscreen HMI supports intuitive operation
- SmartStart walks users through setup process saving valuable time
- EZ-ID synchronizes and pre-populates details of HART-enabled PMSA detectors
- Digital communications supported: Modbus TCP/IP, Modbus RTU (optional), Ethernet/IP, DLN



SENTRY io

### 9010/9020 SIL

The 9010/9020 SIL gas controller provides maximum flexibility, simple operation, and high reliability.

#### Key features:

- Monitors up to 20 channels independently
- Options in 1U rack or wall-mount box (one or two channel)
- Works in combination with a wide range of PMSA gas sensors
- Large LCD display and LED informs about gas concentration, alarm status and more
- RS-485 Modbus RTU, Ethernet for Modbus TCP/IP



9010/9020 SIL 1U rack

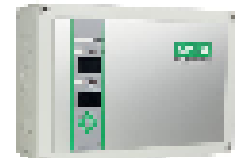

9020 SIL Wall Mount

### GasGard XL

The GasGard XL is a multi-channel wall-mount controller for monitoring hazardous gases in industrial plants.

#### Key features:

- Easily configured, up to eight passive catalytic gas sensors
- Large easy-to-read, multi-language LCD graphic display
- Event log transfer via Ethernet or USB
- Modbus TCP/IP and RTU
- Available only in Europe



GasGard XL

# HVAC Monitors

## Importance of monitoring refrigerant and combustible gases

A building's mechanical rooms is the hub of its heating, ventilation and air conditioning systems. This can include central utility plants, boiler and chiller rooms, mechanical and electrical rooms and fuel rooms. The equipment within these rooms has the potential to leak harmful combustible or toxic gases, including costly and environmentally harmful refrigerant gases. Refrigerant gas is considered as a toxic gas and although refrigerants have low toxicity at high concentrations they can displace oxygen. Oxygen deficiency can cause serious injury or death to workers. Many of these refrigerants are categorized as ozone depleting substances and are highly monitored. Gas monitors satisfy the requirements for equipment room emissions. For economic reasons refrigerant leak detection is encouraged due to costs associated with refrigerant leaks.

### Chillgard® 5000 Refrigerant Leak Monitor

The Chillgard 5000 leak monitor provides the earliest level of detection of costly refrigerant gas leaks in mechanical equipment rooms.

#### Key features:

- Patented photoacoustic infrared (PAIR) technology detects leaks as low as 1 ppm for refrigerant gases
- Intuitive, multi-lingual touchscreen user interface makes it easy to operate
- Predictive maintenance and diagnostics keep you operational
- Modular design makes it easy to maintain and expand sample points
- Digital communications – BACnet (BTL listed) and Modbus
- Pictured with optional strobe



Chillgard 5000

### Chillgard® 5000 Ammonia Monitor

The Chillgard 5000 ammonia monitor provides the earliest level of detection of ammonia leaks in industrial settings.

#### Key features:

- Patented photoacoustic infrared (PAIR) technology detects leaks as low as 10 ppm for ammonia gas
- Intuitive, multi-lingual touchscreen user interface makes it easy to operate
- Predictive maintenance and diagnostic keep you operational
- Modular design makes it easy to maintain and expand sample points
- Digital communications – BACnet (BTL listed) and Modbus
- Optional strobe available



Chillgard 5000 Ammonia Monitor

### Chillgard® 5000 Remote Display

The Chillgard 5000 Remote Display provides a convenient remote display that mimics the Chillgard 5000 Gas Monitor's readings for gas concentration, alarm status, calibration, and fault diagnostics.

#### Key features:

- Verifies the gas levels inside the hazardous area from the safe entry way
- ASHRAE IS compliant for entry way signaling
- Can connect up to 4 remote displays in series
- 7" touch display
- 70dB buzzer
- Optional strobe available

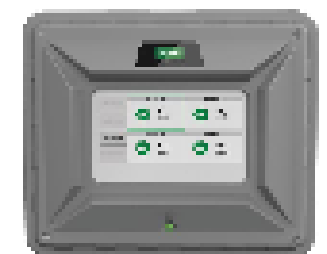

Chillgard 5000 Remote Display

## Services & Solutions

### Improving Detection Coverage with Fire and Gas Mapping

Why perform Fire & Gas Mapping? MSA fire and gas mapping is a solution that assists in the evaluation of flame and gas risks within a process facility and in the reduction of these risks towards an acceptable risk profile. Fire and gas mapping includes placing of detectors in appropriate locations to achieve the best possible detection coverage, with a systematic and numeric method, which also considers external factors, such as wind direction and obstructions. The output of a mapping study includes graphical maps of residual risks, recommended detector placements and numerical estimates of detection coverage.

For further information please check: <https://msasafety.com/fire-mapping>

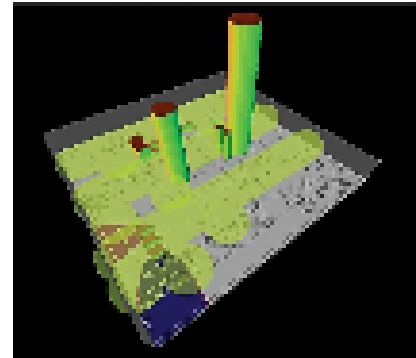

### MSA Services & Solutions – Supporting Your Safety

Alongside the extensive range of top-quality products, MSA Safety also provides a high level of customised service. MSA Safety's comprehensive and versatile range of services helps to ensure that your equipment and systems will always be reliable, economical, and ready for use. MSA Safety is at your service to provide you with the support you need, when you need it.

- Custom System Solutions
- Project Management
- Installation & Commissioning
- System Modification
- Maintenance & Calibration
- Repair & Spare Parts
- Training



### Our Mission

MSA's mission is to see to it that men and women may work in safety and that they, their families, and their communities may live in health throughout the world.

**MSA: SAFEGUARDING PEOPLE, PLACES & THE PLANET.**

Note: This bulletin contains only a general description of the product shown. While product use and performance capabilities are generally described here, instructions should be used by qualified individuals. The product should not be used until the product is accompanied by its manual, which contains detailed information concerning the proper use and care of the product, including any safety steps or cautions, have been thoroughly read and understood. No individuals are subject to change of that use without MSA's registered trademarks of MSA Technology, LLC in the US, Europe, and other Countries. For all other trademarks visit <https://www.msasafety.com/Trademarks>

MSA operates in over 40 countries worldwide. To find an MSA office near you please visit: [msasafety.com/office](https://msasafety.com/office)